

groël

Nonna

The elegance one falls in love with.

The Nonna door handle design, with straight and defined lines is presented on a squared rose. This Italian handle design made in forged brass is conceived in several finishes offering elegance over all and in consequence to always be remembered.

Available in 3 finishes.



POWERCOAT POLISHED NICKEL



POWERCOAT SATIN BRASS



POWERCOAT POLISHED BRASS

groël

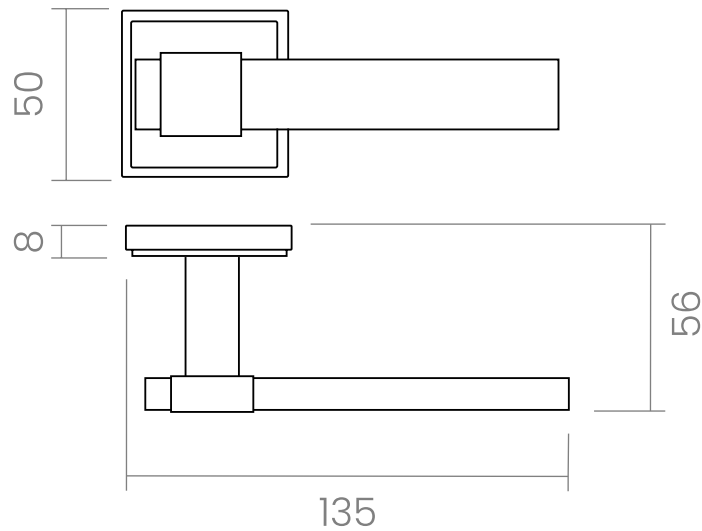







INFO. SPECIFICATIONS

Set of forged brass handles with an 8 mm thick squared rose. Suitable for interior and exterior doors with a thickness between 35-50mm (Groël's standard size)* and with any type of lock.

For wider doors (50mm and above) and/or glass doors, please contact our customer service.

INFO. FINISHES & SKU

	PWNB Powercoat polished nickel	560-R2C-PWNB	
	PWLP Powercoat polished brass	560-R2C-PWLP	
	PWLS Powercoat satin brass	560-R2C-PWLS	

INFO. INCLUDED

- 2x** Lever handles with round rose
- 1x** Square spindle
- 1x** Bag of screws

INFO. CARE INSTRUCTIONS

Clean with a dry cloth. Do not use brass cleaner as it might affect the protective coating.

INFO. DISCLAIMER

Always seek the advice of professionals when installing these handles.
Groël is not responsible for any inadequate installation that may damage the integrity of the product.
Finishes other than Groël's Powercoat are not recommended for wet or humid environments.



Production processes follow ecological norms.



Mechanical guarantee far exceed 200.000 operational cycles



Made of solid brass



Powercoat LIFELONG GUARANTEE