

groël

Elisabeth

A British-flavoured picturesque courtesy.

The Elisabeth door handle design, governor by its individual nature, is assembled with a round rose. Due to its classic appearance, this Italian handle made in forged brass is conceived for interior and exterior doors in several finishes. Elisabeth will imbue your home with the presence of her legacy.

Available in 3 finishes.



POWERCOAT POLISHED BRASS



POWERCOAT POLISHED NICKEL

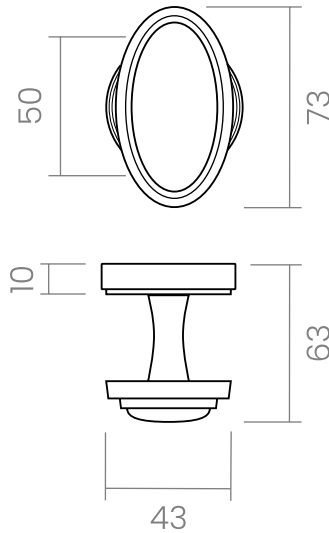







INFO. SPECIFICATIONS

Set of forged brass handles with an 8 mm thick round rose. Suitable for interior and exterior doors with a thickness between 35-50mm (Groël's standard size)* and with any type of lock.

For wider doors (50mm and above) and/or glass doors, please contact our customer service.

INFO. FINISHES & SKU

	PWNB <i>Powercoat polished nickel</i>	580-R3-PWNB	
	PWLP <i>Powercoat polished brass</i>	580-R3-PWLP	
	PWLS <i>Powercoat satin brass</i>	580-R3-PWLS	

INFO. INCLUDED

- 2x** Lever handles with round rose
- 1x** Square spindle
- 1x** Bag of screws

INFO. CARE INSTRUCTIONS

Clean with a dry cloth. Do not use brass cleaner as it might affect the protective coating.

INFO. DISCLAIMER

Always seek the advice of professionals when installing these handles. Groël is not responsible for any inadequate installation that may damage the integrity of the product. Finishes other than Groël's Powercoat are not recommended for wet or humid environments.



Production processes follow ecological norms.



Mechanical guarantee far exceed 200.000 operational cycles



Made of solid brass



Powercoat LIFELONG GUARANTEE