

groël

Swim

The warmth of a charming minimalism.

The Swim door handle design, has a simple and natural style and is presented on a round rose. This Italian handle design is made in high quality forged brass, is conceived for interior and exterior doors in numerous finishes giving a wink to every lover of delicate curves on planes.

Available in 3 finishes.



POLISHED CHROME



POWERCOAT INOX



SATIN CHROME

groël

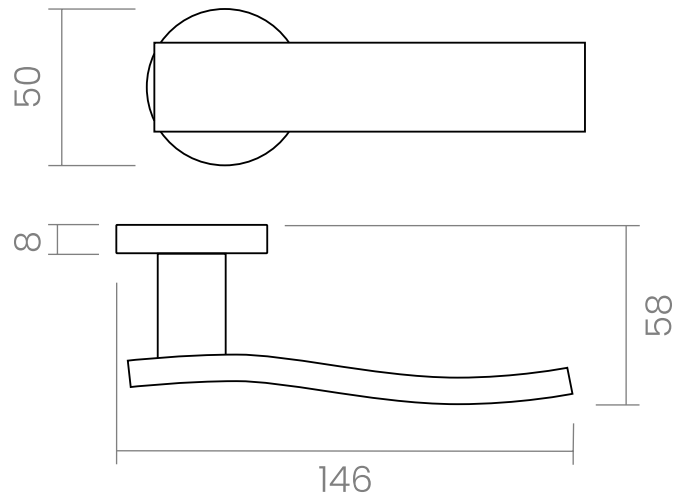







INFO. SPECIFICATIONS

Set of forged brass handles with an 8 mm thick round rose. Suitable for interior and exterior doors with a thickness between 35-50mm (Groël's standard size)* and with any type of lock.

For wider doors (50mm and above) and/or glass doors, please contact our customer service.

INFO. FINISHES & SKU

 CR	<i>Polished chrome</i>	157-R8-CR	
 CS	<i>Satin chrome</i>	157-R8-CS	
 PWIX	<i>Powercoat inox</i>	157-R8-PWIX	

INFO. INCLUDED

- 2x** Lever handles with round rose
- 1x** Square spindle
- 1x** Bag of screws

INFO. CARE INSTRUCTIONS

Clean with a dry cloth. Do not use brass cleaner as it might affect the protective coating.

INFO. DISCLAIMER

Always seek the advice of professionals when installing these handles.

Groël is not responsible for any inadequate installation that may damage the integrity of the product. Finishes other than Groël's Powercoat are not recommended for wet or humid environments.



Production processes follow ecological norms.



Mechanical guarantee far exceed 200.000 operational cycles



Made of solid brass



Chrome III
15 YEARS GUARANTEE



Powercoat
LIFELONG GUARANTEE