

EN

TECHNICAL SPECIFICATION

STANDARD 2 WAY SWITCH.
RATED AT 10AX 250V~ AC ONLY.

IMPORTANT NOTES

PLEASE READ BEFORE INSTALLING

These products must be installed in accordance with the latest Building and IEE wiring regulations. If in any doubt, please contact a qualified electrician.

BACK BOXES

We recommend you to use a UK back box to install your product. Please note that the minimum recommended depth for the mounting box is 25mm. Back boxes are available to purchase from us, please see recommended sizes below:

TOGGLE PLATE	RECOMMENDED BACK BOX
1G	1G UK Back box – SKU# ELB921
2G	2G UK Back Box – SKU# ELB922

WARRANTY INFORMATION

The Warranty Period of Two (2) years from the date of the original purchase.

RECYCLING ELECTRICAL PRODUCTS

Buster and Punch encourages all its customers to make note of this symbol and avoid putting any waste electrical goods in your domestic waste bin or container. Please ensure you take your waste electrical goods to a suitable facility for disposal.



1



BEFORE COMMENCING WORK, ISOLATE THE MAINS POWER SUPPLY AND REMOVE THE FUSE IN THE FUSE BOX OR SWITCH OFF THE CIRCUIT BREAKER IN THE CONSUMER UNIT.



2

If unit is to be used as a replacement for an existing product, remove existing unit from its location and disconnect the wiring.



CAUTION:
Verify power is OFF to switch before proceeding.

3

Certain items in the range will not fit into a 4 lug box. If such a box has been previously installed the top and bottom lugs should be removed or bent back to avoid contact with the interior.

4 D) 10AX INTERMEDIATE SWITCH AND TOGGLE SWITCH

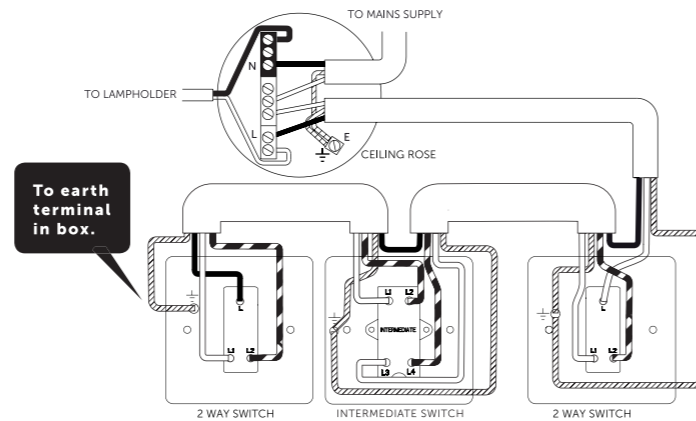

4

Connect the wires as shown in appropriate wiring diagrams. Use green/yellow sleeving on earth conductors that are not insulated. Ensure terminals are properly tightened and no bare wire is visible. Push back unit into moulding box making sure conductors are not trapped.



4 A)

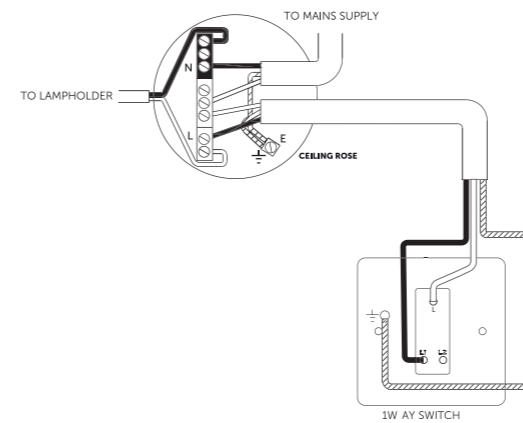

4 B) DIMMER ON 2 WAY CIRCUIT

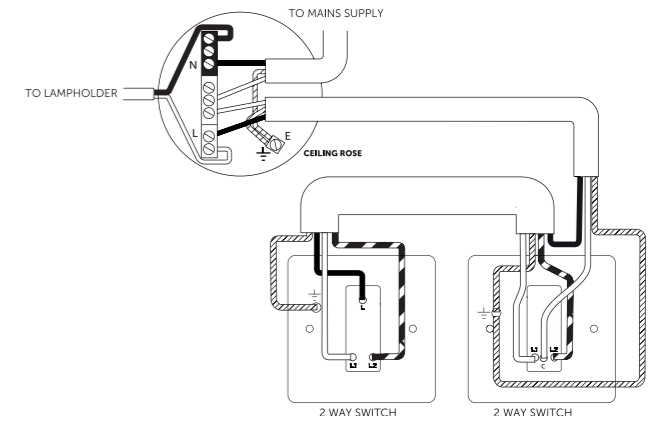

4 C) 2 WAY CIRCUIT

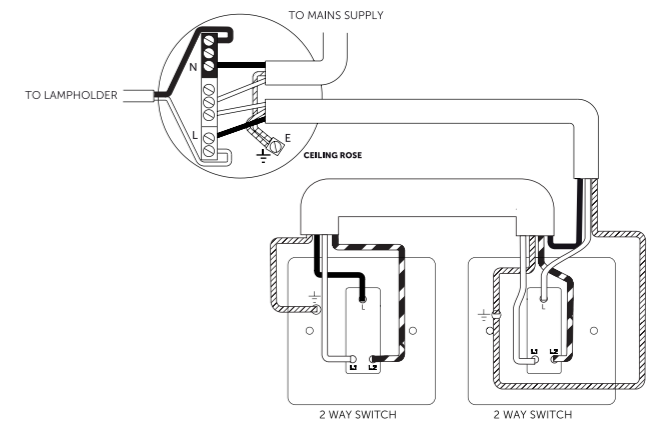

5

Use a cross head electric or manual screwdriver to fit the special countersunk screws until tight.*



CAUTION:
To reduce the risk of discolouration or tarnishing, avoid installation on wet plaster.

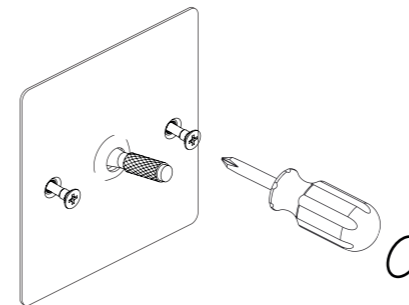

6

By hand, screw the coin caps into the end of the screws. Use the plastic coin cap tool to fully tighten the coin caps.**

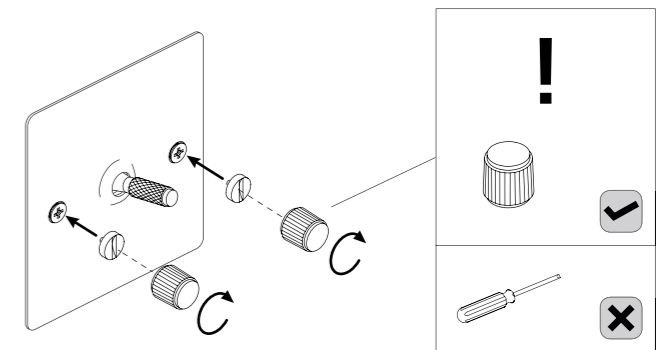

** Do NOT use a standard screw driver to tighten the coin caps. This may damage the cap and is not covered under warranty. Plastic coin cap tool must be used by hand only.

7

Turn power back on.



* Please ensure screws are sufficiently tight to support the product but please do not over tighten as this may cause some deformation to the plate or damage the screw.

BUSTER + PUNCH

ELECTRICITY / TOGGLE SWITCH

TECH SPEC



1G TOGGLE SWITCH
STEEL



2G TOGGLE SWITCH
BRASS



3G TOGGLE SWITCH
SMOKED BRONZE

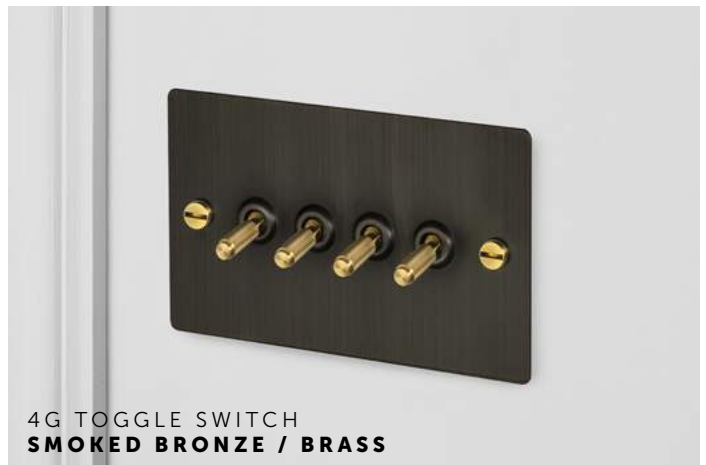

4G TOGGLE SWITCH
SMOKED BRONZE / BRASS

TOGGLE SWITCH

A toggle switch made from solid metal with a diamond-cut knurled knob to feel amazing with every touch. The switch is finished with a flat plate and our signature solid metal penny buttons. Available in 12 different metal combinations. You can also team them up with our dimmers, plug sockets and euro plates in matching finishes.

busterandpunch.com
info@busterandpunch.com

BUSTER + PUNCH

1G TOGGLE SWITCH

TECH SPEC

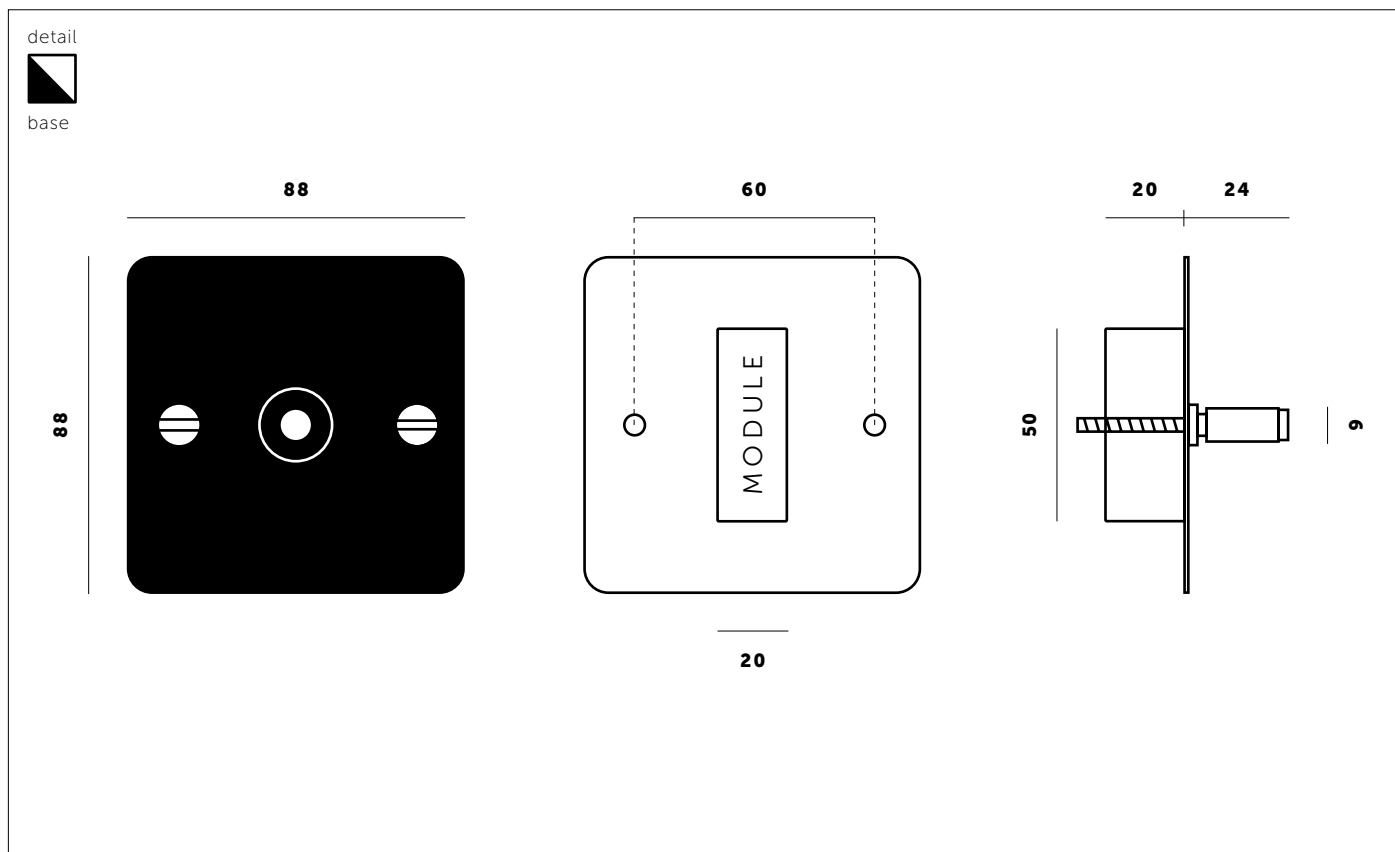

SPECIFICATIONS

Single switch
2-way
10 AX
240 V

CE-tested for use throughout Europe.

Recommended back box:
1G square back box - 47mm depth
Can be supplied on request

Care instructions
Wipe with damp cloth with no loose hairs, avoid using any chemicals. Please note all finishes are prone to aging.

FINISH (base / detail)	SKU	FINISH (base / detail)	SKU
white	UK-TO-CO-1G-WH-A	smoked bronze	UK-TO-CO-1G-SM-A
white / brass	UK-TO-CO-1G-WH-BR-A	smoked bronze / brass	UK-TO-CO-1G-SM-BR-A
steel	UK-TO-CO-1G-ST-A	black	UK-TO-CO-1G-BL-A
steel / brass	UK-TO-CO-1G-ST-BR-A	black / brass	UK-TO-CO-1G-BL-BR-A
brass	UK-TO-CO-1G-BR-A		

BUSTER + PUNCH

2G TOGGLE SWITCH

TECH SPEC

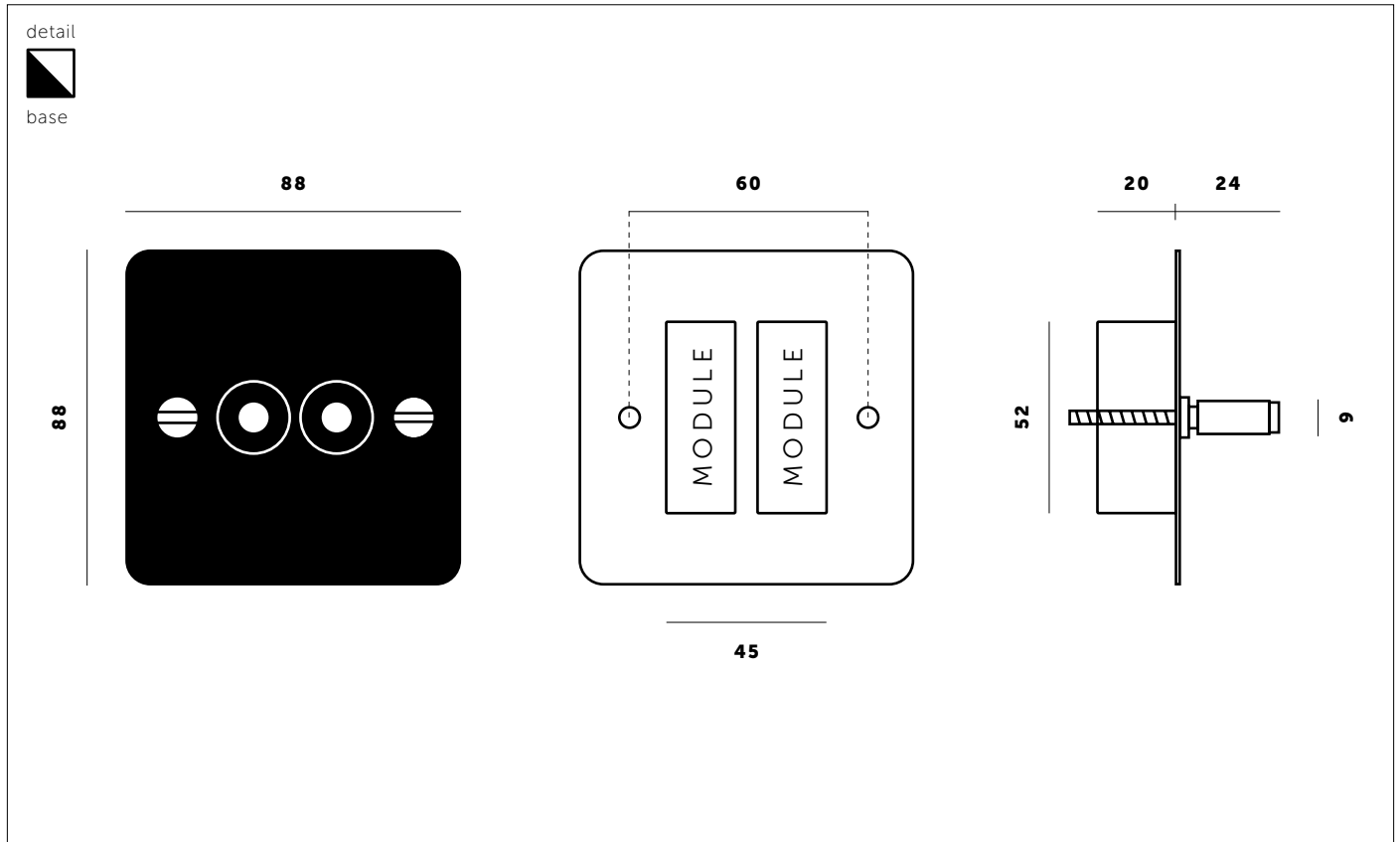

SPECIFICATIONS

Double switch
2-way
10 AX
240 V









CE-tested for use throughout Europe.

Recommended back box:

1G square back box - 47mm depth
Can be supplied on request

Care instructions

Wipe with damp cloth with no loose hairs, avoid using any chemicals. Please note all finishes are prone to aging.

FINISH (base / detail)	SKU	FINISH (base / detail)	SKU
 white	UK-TO-CO-2G-WH-A	 smoked bronze	UK-TO-CO-2G-SM-A
 white / brass	UK-TO-CO-2G-WH-BR-A	 smoked bronze / brass	UK-TO-CO-2G-SM-BR-A
 steel	UK-TO-CO-2G-ST-A	 black	UK-TO-CO-2G-BL-A
 steel / brass	UK-TO-CO-2G-ST-BR-A	 black / brass	UK-TO-CO-2G-BL-BR-A
 brass	UK-TO-CO-2G-BR-A		

BUSTER + PUNCH

3G TOGGLE SWITCH

TECH SPEC

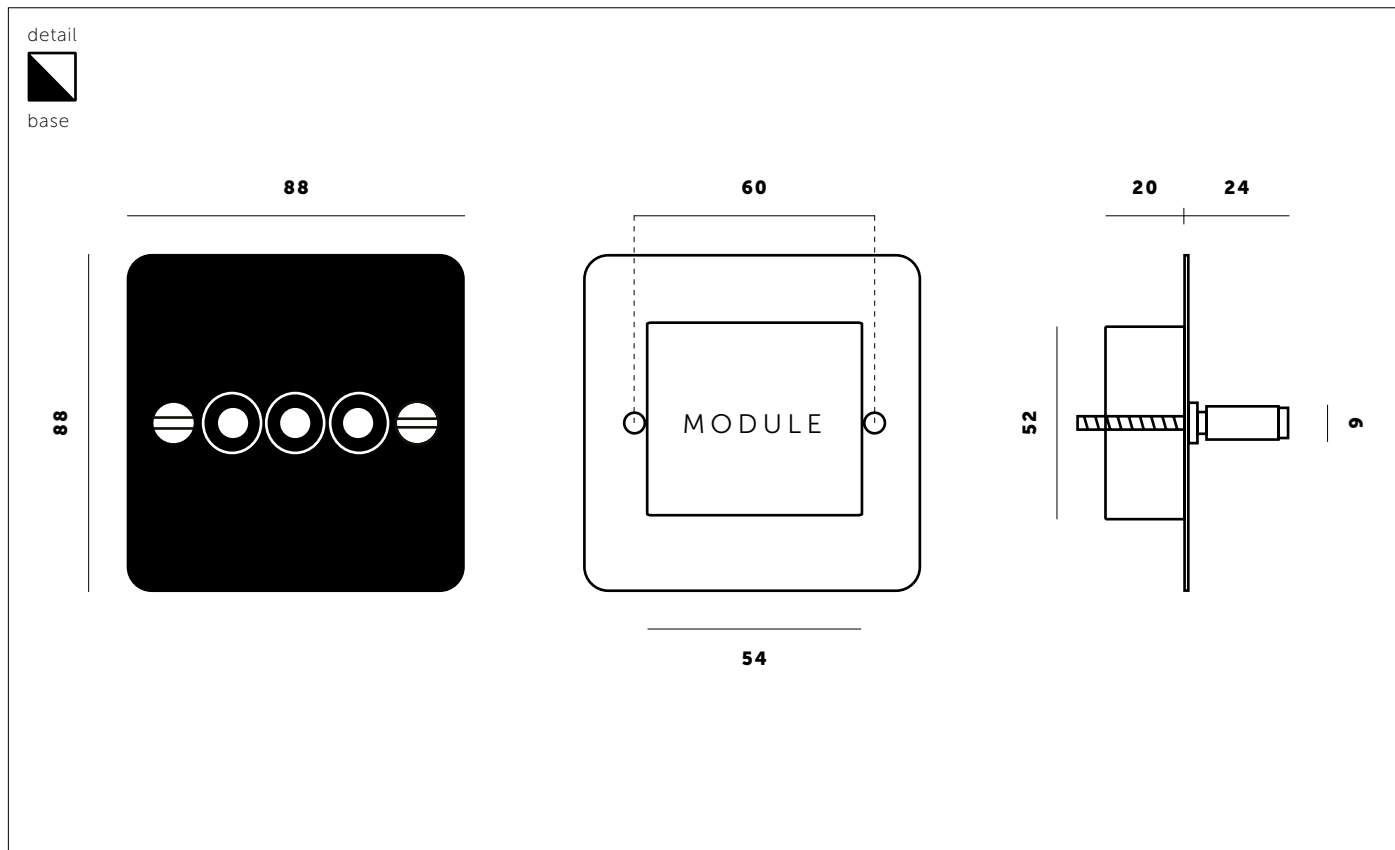

SPECIFICATIONS

Triple switch
2-way
10 AX
240 V

CE-tested for use throughout Europe.

Recommended back box:

1G square back box - 47mm depth
Can be supplied on request

Care instructions

Wipe with damp cloth with no loose hairs, avoid using any chemicals. Please note all finishes are prone to aging.

FINISH (base / detail)	SKU	FINISH (base / detail)	SKU
 white	UK-TO-CO-3G-WH-A	 smoked bronze	UK-TO-CO-3G-SM-A
 white / brass	UK-TO-CO-3G-WH-BR-A	 smoked bronze / brass	UK-TO-CO-3G-SM-BR-A
 steel	UK-TO-CO-3G-ST-A	 black	UK-TO-CO-3G-BL-A
 steel / brass	UK-TO-CO-3G-ST-BR-A	 black / brass	UK-TO-CO-3G-BL-BR-A
 brass	UK-TO-CO-3G-BR-A		



4G TOGGLE SWITCH

TECH SPEC

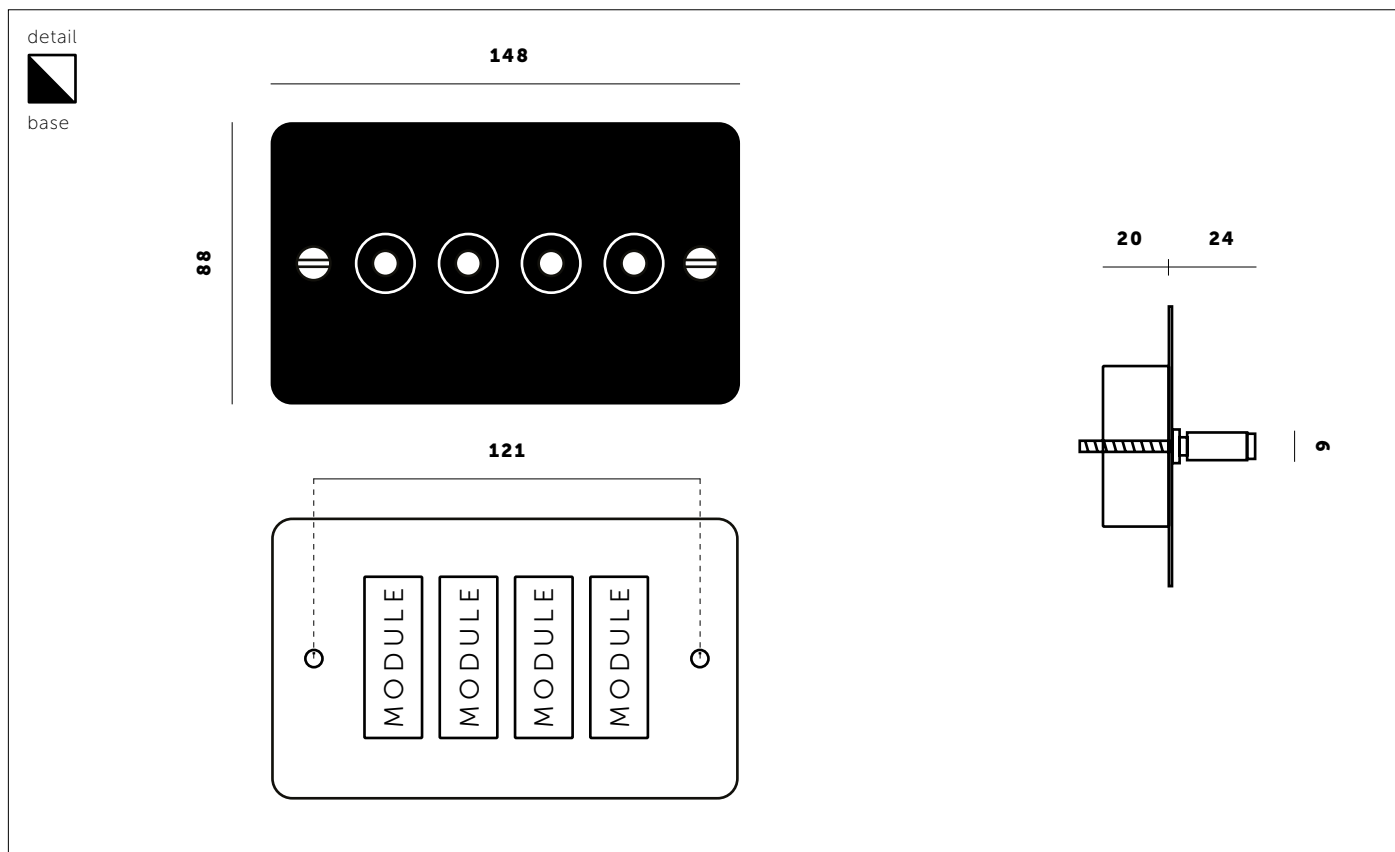

SPECIFICATIONS

Quadruple switch
 2-way
 10 AX
 240 V

CE-tested for use throughout Europe.

Recommended back box:
 2G square back box - 47mm depth
 Can be supplied on request

Care instructions
 Wipe with damp cloth with no loose hairs, avoid using any chemicals. Please note all finishes are prone to aging.

FINISH (base / detail)	SKU	FINISH (base / detail)	SKU
white	UK-TO-CO-4G-WH-A	smoked bronze	UK-TO-CO-4G-SM-A
white / brass	UK-TO-CO-4G-WH-BR-A	smoked bronze / brass	UK-TO-CO-4G-SM-BR-A
steel	UK-TO-CO-4G-ST-A	black	UK-TO-CO-4G-BL-A
steel / brass	UK-TO-CO-4G-ST-BR-A	black / brass	UK-TO-CO-4G-BL-BR-A
brass	UK-TO-CO-4G-BR-A		

BUSTER + PUNCH

1G INTERMEDIATE TOGGLE SWITCH

TECH SPEC

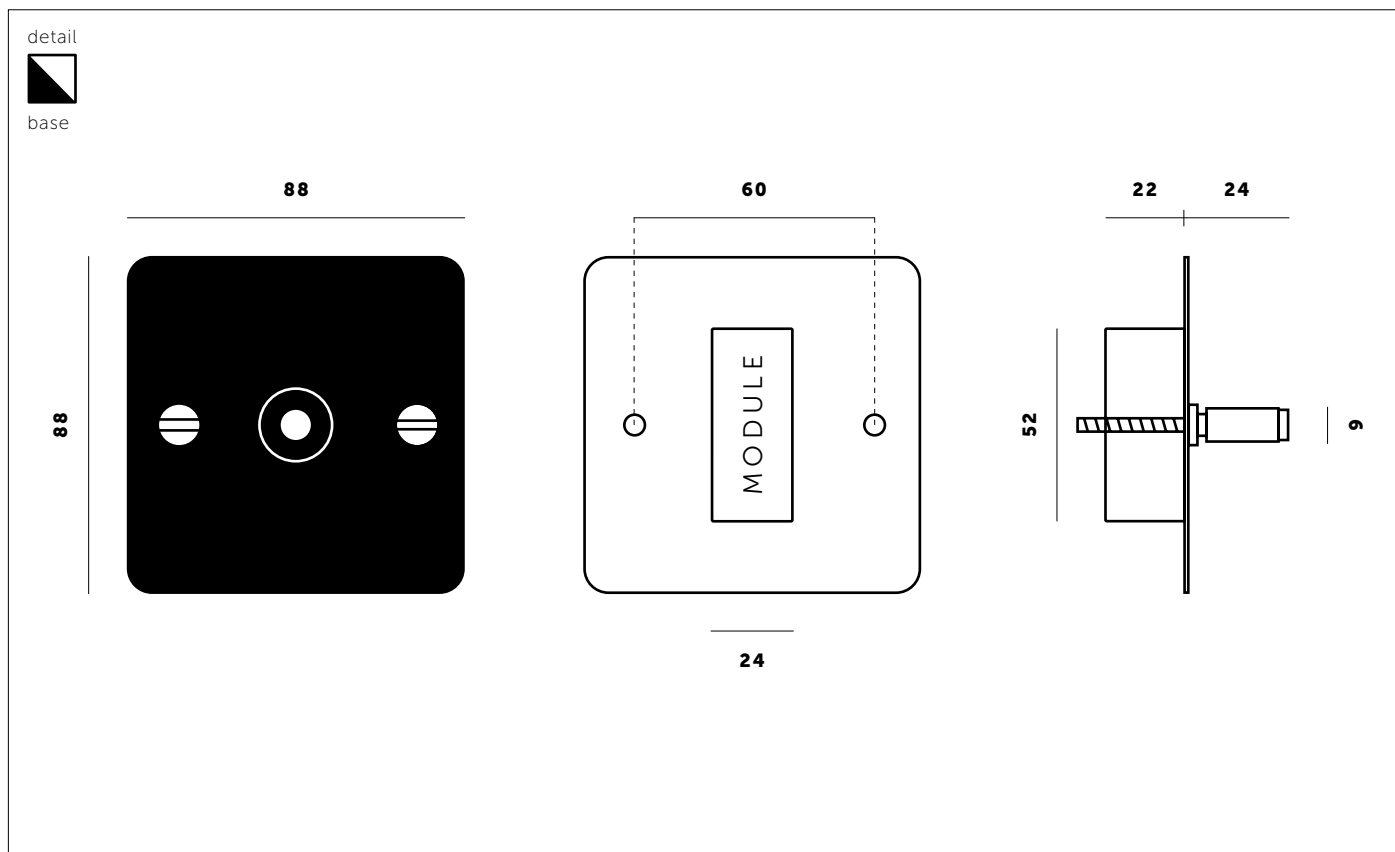

SPECIFICATIONS

Single switch
3-way
240 V

Not supplied in 2G, 3G or 4G

CE-tested for use throughout Europe.

Recommended back box:

1G square back box - 47mm depth
Can be supplied on request

Care instructions

Wipe with damp cloth with no loose hairs, avoid using any chemicals. Please note all finishes are prone to aging.

FINISH (base / detail)	SKU	FINISH (base / detail)	SKU
 white	UK-TO-CO-INT-WH-A	 smoked bronze	UK-TO-CO-INT-SM-A
 white / brass	UK-TO-CO-INT-WH-BR-A	 smoked bronze / brass	UK-TO-CO-INT-SM-BR-A
 steel	UK-TO-CO-INT-ST-A	 black	UK-TO-CO-INT-BL-A
 steel / brass	UK-TO-CO-INT-ST-BR-A	 black / brass	UK-TO-CO-INT-BL-BR-A
 brass	UK-TO-CO-INT-BR-A		

TOGGLE SWITCH

FAQ SHEET

CATEGORY	QUESTION	ANSWER
GENERAL	How do I clean my electricity collection?	A slight damp microfiber cloth is best, never use any chemicals as this will damaged the metal surface.
BACK BOXES	What size back boxes do you recommend?	1G: W 70mm x H 70mm x D 47mm, square back box 2G: W 140mm x H 70mm x D 47mm, square back box Back boxes can be supplied on request.
TOGGLE	Are your toggles 2 way or 3 way?	All our toggles are 2 ways. We also supply intermediate switches in 1G only which are 3 way.
TOGGLE	Are the toggles available as dimmers?	No, unfortunately they are not.
TOGGLE	Can we remove and replace the toggle on the plate?	No, the toggles are fixed to the plate and are unable to be removed.
TOGGLE	Do you manufacture / stock spring loaded toggles?	No, unfortunately we don't.
TOGGLE	Can I mix a toggle switches with a dimmer?	No, unfortunately this is not possible.
TOGGLE	Can I put an intermediate on a 2G plate?	No, unfortunately this is not possible.
TOGGLE	Are your toggles switches dimmable?	No, unfortunately this is not possible.
TOGGLE	The spring action has gone in my toggle?	Please contact Buster + Punch for any faulty product. Please supply photos or videos.